

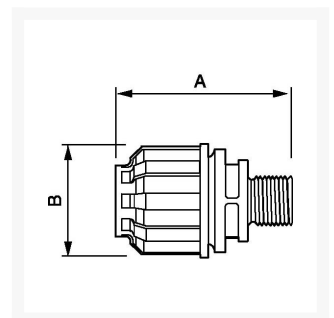

Coupling 20 mm 1/2" male

Product Images



Additional Information

SKU	9ALRPM2012
EAN	08712418282788
Weight (kg)	0.051000
Length (mm)	66
Width (mm)	47
Construction (material)	Polyamide
Diameter Ø (mm)	20
Maximum pressure (bar)	13 at 40°C
Thread size (")	1/2
Thread type	Male

