

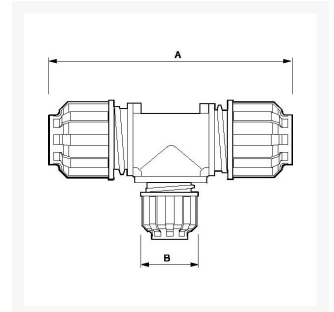

Tee Reducing coupling 40 x 25 x 40 mm female

Product Images



Additional Information

SKU	9ALRTR4025
EAN	08712418282764
Weight (kg)	0.508000
Length (mm)	182
Width (mm)	52
Construction (material)	Polyamide
Diameter Ø (mm)	40 x 25 x 40
Maximum pressure (bar)	13 at 40°C

