

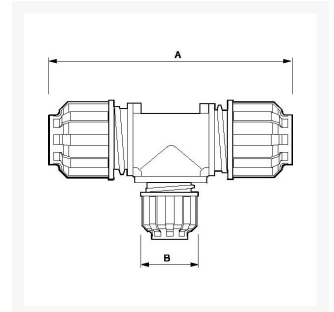

Tee Reducing coupling 25 x 20 x 25 mm female

Product Images



Additional Information

SKU	9ALRTR2520
EAN	08712418282733
Weight (kg)	0.202000
Length (mm)	132
Width (mm)	47
Construction (material)	Polyamide
Diameter Ø (mm)	25 x 20 x 25
Maximum pressure (bar)	13 at 40°C

